



This manual contains important safety information concerning equipment installation and operation. Strictly comply with this information to avoid causing damage to people and property.



The use of this equipment with chemical radioactive material is strictly forbidden!



## OPERATING MANUAL FOR THE "LDOSIN" SERIES DIGITAL INSTRUMENT



Instrument working range must be specified when ordering. Examples on this manual can be different from instrument's values.

Read carefully!



ENGLISH Version

R2-08-20



NORME CE  
EC RULES(STANDARD EC)  
NORMAS DE LA CE

Direttiva Bassa Tensione  
Low Voltage Directive  
Directiva de baja tensión } 2014/35/UE

Direttiva EMC Compatibilità Elettromagnetica  
EMC electromagnetic compatibility directive  
EMC directiva de compatibilidad electromagnética } 2014/30/UE



## GENERAL SAFETY GUIDELINES

### Danger!

In emergencies the instrument should be switched off immediately! Disconnect the power cable from the power supply!

When installing always observe local regulations!

Manufacturer is not liable for any unauthorized use or misuse of this product that may cause injury, damage to persons and / or materials.

### Caution!

Instrument must be accessible at all times for both operating and servicing. Access must not be obstructed in any way!

Feeder should be interlocked with a no-flow protection device to automatically shut-off the pumps when there is no flow!

Pumps and accessories must be serviced and repaired by qualified and authorized personnel only!

Always discharge the liquid end before servicing the instrument!

Empty and rinse the liquid end before work on a pump which has been used with hazardous or unknown chemicals!

Always read chemical safety datasheet!

Always wear protective clothing when handling hazardous or unknown chemicals!

Instrument must be operated / serviced by trained technicians only!

All connection operations must be performed while the instrument is not connected to main supply!

Missed activation for Min/Max alarm and Maximum Dosing Alarm may cause hazardous overdosing!

---

## SUMMARY

---

GENERAL DESCRIPTION .....	4
INSTRUMENT INSTALLATION .....	5
OPERATING PRINCIPLES.....	7
OPERATING LOGIC.....	7
USER MENU.....	10
INSTRUMENT'S MESSAGES .....	11
PROGRAMMING .....	13
MAIN MENU ACCESS .....	13
MAIN MENU .....	14
1 - INPUT PROBE CALIBRATION .....	15
2 - OUTPUT PROBE CALIBRATION .....	16
3 – SETPOINT OUT .....	17
4 – SETPOINT IN .....	19
5 - LOW LEVEL .....	21
6 - HI LEVEL .....	22
7 - LOW PRESSURE .....	23
8 - MAX PRESSURE .....	25
9 - PUMP TEMP IN .....	26
10 - FILTER .....	27
11 - WASHING (MEMBRANE WASHING CYCLE).....	28
12 - OUTPUT ALARM .....	30
13 - RESET HR COUNTER .....	31
14 - SYSTEM TEST .....	32
15 - ALARM TEST .....	32
16 – LANGUAGE .....	32
16 - PASSWORD.....	33
17 – (PERFORM MAINTENANCE) MESSAGE .....	33
19 – PUMP DOS. IN .....	34
20 – IN STAND BY .....	35
21 – PUMP DELAY .....	36
DIMENSION .....	38
RACK MOUNTING DIMENSION.....	39

# Introduction

## GENERAL DESCRIPTION

The "LDOSIN" instrument enables the process and control of osmosis in industrial plants. The value readings are shown on a backlit LCD display that can be easily read even in very bright environments. The instrument is housed in a plastic container, can be wall-mounted and has degree of protection IP65.

The overall dimensions are 225x215x125mm.

Available in rack mounting version 180x220x80mm).

Average power consumption: 10W.

Max current load: 1KW.

## INSTRUMENT PANEL

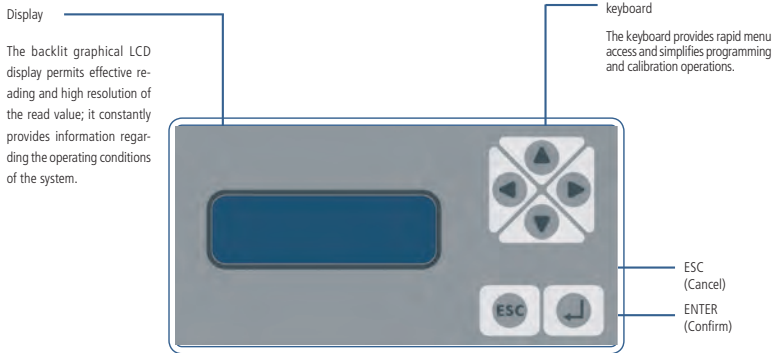

Use the keyboard to select an item or to increase/decrease a value (up, down, right, left).

Once the function/item is displayed, press the "enter" key to confirm or press the "ESC" key to cancel or exit from the various screens.

From main menu, press "UP" or "DOWN" keys to alternate instruments configuration info views.

"LDOSIN" is two-version available:

### VERSION 1:

incoming water conductivity meter from 000 to 999 uS

outgoing conductivity meter from 00.0 to 99.9 uS

N.B. - Version 1: use SS input electrodes K=1 and SS output electrodes K=0,1.

### VERSION 2:

incoming water conductivity meter from 00.0 to 9.99 mS

outgoing conductivity meter from 00.0 to 999 uS

N.B. - Version 2 use input and output graphite electrodes (K=1).

### VERSION 3:

incoming water conductivity meter from 00.0 to 999 uS

outgoing conductivity meter from 00.0 to 999 uS

Version no. is displayed at start up.

LDOSIN  
VER: XX SW V:X.X

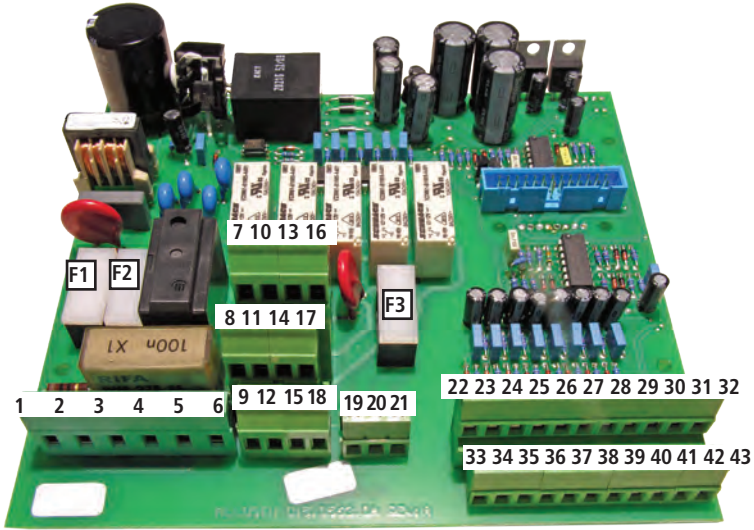

**230 VAC MAINBOARD CONNECTIONS:**

- F1: Main protection Fuse (6.3A T)
- F2: Instrument protection Fuse (2A T)
- F3: Alarm protection Fuse (2A T)

1[L], 2[Earth], 3[N] : Main power input 230VAC

4[L], 5[Earth], 6[N] :230VAC output for reverse osmosis pump (1 HP = 735,49875 W)

7[L], 8[Earth], 9[N] : METERING PUMP 230VAC output  
 10[L], 11[Earth], 12[N] : SOLENOID VALVE 1 (EV IN) 230VAC output

13[L], 14[Earth], 15[N] : SOLENOID VALVE 2 (EV OUT) 230VAC output

16[L], 17[Earth], 18[N] : SOLENOID VALVE 3 (EV PURGE) 230VAC output

19[N.O.], 20[C], 21[N.C.] : Alarm output with contacts without voltage (F3 protected output)

22[GND], 23[Input] : High level probe input  
 24[GND], 25[Input] : High pressure pressure-switch input  
 26[GND], 27[Input] : Theroswitch input (pressure pump motor)  
 28[GND], 29[Input] : Metering pump alarm input  
 30[Shield], 31[Black wire - signal], 32[Red wire - signal] :

Conductivity probe for osmosis output  
 White and green wires not connected.

33[GND], 34[Input] :Low level probe input  
 35[GND], 36[Input] : Low pressure pressure-switch input  
 37[GND], 38[Input] : Stand-by input  
 39[GND], 40[Input] : Filter input  
 41[Shield], 42[Black wire - signal], 43[Red wire - signal] :

Conductivity probe for osmosis input  
 White and green wires not connected.



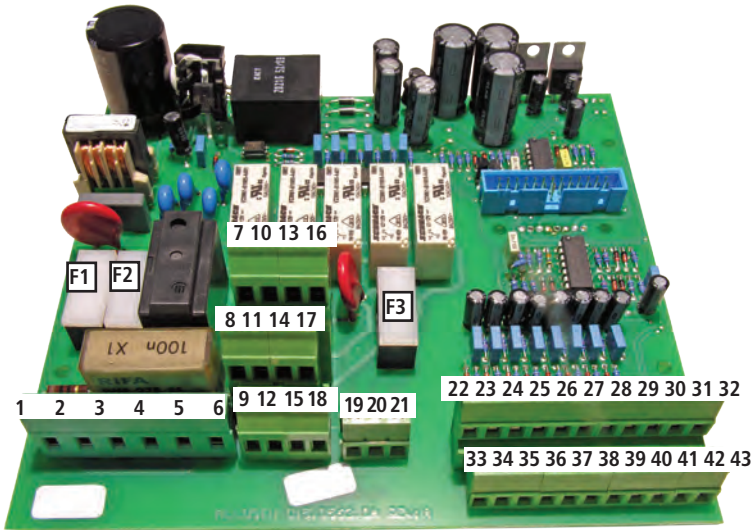

## 24 VAC MAINBOARD CONNECTIONS:

F1: Main protection Fuse (6.3A T)  
 F2: Instrument protection Fuse (2A T)  
 F3: Alarm protection Fuse (2A T)

1[24VAC], 2[Earth], 3[0] : Main power input 24VAC

4[24VAC], 5[Earth], 6[0] : 24VAC output for reverse osmosis pump (check supply)

7[24VAC], 8[Earth], 9[0] : 24VAC OUTPUT METERING PUMP  
 10[24VAC], 11[Earth], 12[0] : 24VAC OUTPUT SOLENOID VALVE 1 (EV IN)

13[24VAC], 14[Earth], 15[0] : 24VAC OUTPUT SOLENOID VALVE 2 (EV OUT)

16[24VAC], 17[Earth], 18[0] : 24VAC OUTPUT SOLENOID VALVE 3 (EV PURGE)

19[N.O.], 20[C], 21[N.C.] : Alarm output with contacts without voltage (F3 protected output)

22[GND], 23[Input] : High level probe input  
 24[GND], 25[Input] : High pressure pressure-switch input  
 26[GND], 27[Input] : Thermoswitch input (pressure pump motor)  
 28[GND], 29[Input] : Metering pump alarm input  
 30[Shield], 31[Black wire - signal], 32[Red wire - signal] :

Conductivity probe for osmosis output  
 White and green wires not connected.

33[GND], 34[Input] : Low level probe input  
 35[GND], 36[Input] : Low pressure pressure-switch input  
 37[GND], 38[Input] : Stand-by input  
 39[GND], 40[Input] : Filter input  
 41[Shield], 42[Black wire - signal], 43[Red wire - signal] :

Conductivity probe for osmosis input  
 White and green wires not connected.

Uscite protette da fusibile F1

---

## OPERATING PRINCIPLES

---

### OPERATING LOGIC

The instrument controls and drives a reverse osmosis system. It operates basing on collection tank levels. In "low" level condition, the instrument starts water production: it opens the input solenoid valve, starts the pump and starts the pressure pump.

To avoid damages, a 3 sec. delay is given after the input solenoid valve opening.

When "high" level is reached, LDOSIN goes in stand-by mode: it stops the pump, the input solenoid valve and the pressure pump.

Water production and stand-by are controlled by levels: low for water production, high for stand-by.

It is possible to set low level (or high level) only or both. If both disabled, osmosis (water production) is always active.

Instrument's modes:

1) WATER PRODUCTION: all outputs active (solenoid valve 1, pump and pressure pump).

2) STAND-BY: all outputs disabled.

3) MEMBRANE WASHING - or M.W. - (to prevent deposits on membrane surface): if enabled in the main menu, a membrane washing can be done at instrument's power on, before/after water production and/or cyclically after a set number of hours.

### "LOAD DEFAULT" PROCEDURE

This procedure deletes all programming data set. It reloads the default data of the pump.

Follow this instructions:

- unplug power supply;

- pressing both "UP" and "RIGHT" keys, plug in power supply.

For few seconds, the display shows LOAD DEFAULT before start up the pump.

### "RESET PASSWORD" PROCEDURE

This procedure resets the password set and reloads the default password of the pump ("0000").

Follow this instructions:

- unplug power supply;

- pressing both "UP" and "ESC" keys, plug in power supply.

For few seconds, the display shows RESET PASSWORD before start up the pump.

### "WAITING ON" OR "WAITING OFF" MESSAGGES

The instrument is powering on or off.

---

---

## OUTPUT ACTIVATION

To avoid piping damages due to "water hammers", a 3 sec. delay is given between pump on (or off) and solenoid valve on (or off) (Ev1,2,3) and a 2 sec. delay is given between pump on (or off) and pressure pump on (or off).

## OUTPUT SEQUENCES

1-1 At instrument power on, if a M.W. is enabled (10B menu: set PUMP YES and EVIN YES), the sequence is:

- EV1/EV2/EV3 on
- 3" pause
- Pump on
- M.W. (setup time)
- At washing end: Pump off
- 3" pause
- EV1, EV2, EV3 off
- Levels control

1-2 At instrument power on, if a M.W. is disabled (DIS):

- Levels control

2-1 At low level reaching and M.W. enabled with pump and EVIN (1), the sequence is:

- EV1, EV2, EV3 on
- 3" pause
- Pump on
- M.W. (setup time)
- At washing end: Pump off
- 3" pause
- EV1 on; EV2, EV3 off;
- 3" pause
- Pump on
- 2" pause
- Pressure pump on
- Water production until high level is reached

2-2 At low level reaching and M.W. enabled without pump and EVIN (1), the sequence is:

- EV2, EV3 on
- M.W. (setup time)
- At washing end: EV1 on, EV2, EV3 off
- 3" pause
- Pump on
- 2" pause
- Pressure pump on
- Water production until high level is reached

2-3 At low level reaching and M.W. disabled, the sequence is:

- EV1 on
- 3" pause
- Pump on
- 2" pause
- Pressure pump on
- Water production until high level is reached



---

---

3-1 At high level reaching and M.W. enabled with pump and EVIN (1), the sequence is:

- Pressure pump off
- 2" pause
- Pump off
- 3" pause
- EV1: on; EV2, EV3: on
- 3" pause
- Pump on
- M.W. (setup time)
- Pump off
- 3" pump
- EV1, EV2, EV3: off
- Stand-by until low level is reached

3-2 At high level reaching and M.W. enabled without pump and EVIN (1), the sequence is:

- Pressure pump off
- 2" pause
- Pump off
- 3" pause
- EV1: off; EV2, EV3: on
- M.W. (setup time)
- EV2, EV3: off
- Stand-by until low level is reached

3-3 At high level reaching and M.W. disabled, the sequence is:

- Pressure pump off
- 2" pause
- Pump off
- 3" pause
- EV1: off
- Stand-by until low level is reached

---

---

## USER MENU

If osmosis is active, display shows plant status:

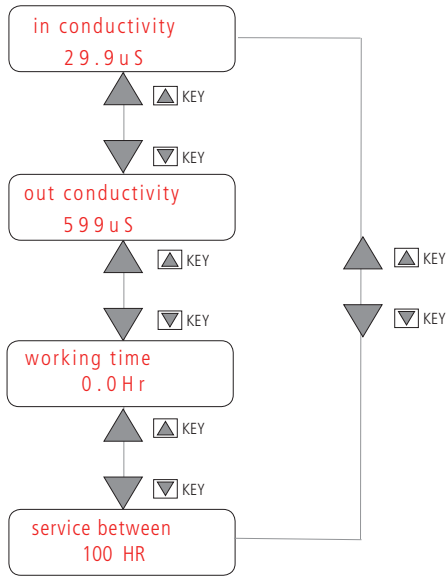

NOTE  
Working time hours expressed in decimals.

If a membrane washing is running, it displays:  
Remaining time is the washing time countdown.

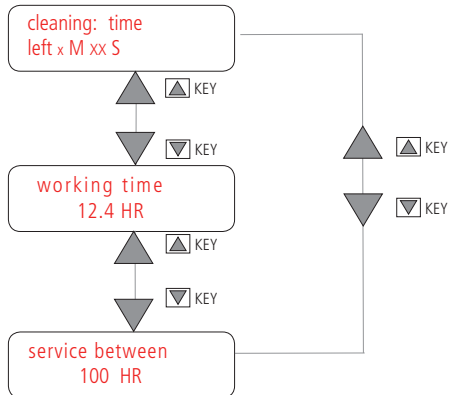

## INSTRUMENT'S MESSAGES

### "SYSTEM WAITING!" - CONDUCTIVITY ALARM

A "System waiting!" message is displayed:

- if HIGH LEVEL is reached;
- if on STAND-BY mode;
- if an after-wash conductivity alarm occurs (see p. 16-17);
- if a FAILED DOSAGE alarm occurs;
- if a FILTER INPUT alarm occurs.

In the above cases, all outputs will be disabled:

- Pressure pump off
- 2" pause
- Pump off
- 3" pause
- EV1: off

To avoid piping damages due to "water hammers", a 3 sec. delay is given between pump off and solenoid valve off (Ev1) and a 2 sec. delay is given between pump off and pressure pump off.

In these cases:

- HIGH LEVEL: wait until level decreases. The water production stops and the instrument displays:

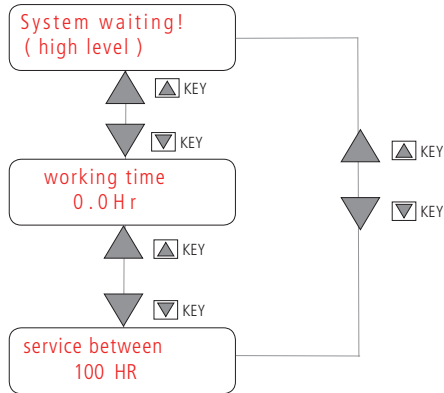

- STAND-BY: disable stand-by mode.

System waiting!  
stand by

- FAILED DOSAGE: check metering pump. During water production, metering pump alarm input and alarm output are active and the display shows:

System waiting!  
failed dosage

- FILTER INPUT: wait the softener, if any, ends the regeneration. Filter input and alarm output are active and the display shows:

System waiting!  
filter input

---

---

## "SYSTEM STOPPED!" - CONDUCTIVITY ALARM - HI AND LOW LEVEL CONTACT

When an alarm stopping instrument occurs (HI PRESSURE, LOW PRESSURE, PUMP TEMP., CONDUCTIVITY ALARM, HI AND LOW LEVEL CONTACT), all outputs will be disabled:

- Pressure pump off
- 2" pause
- Pump off
- 3" pause
- EV1: off

To avoid piping damages due to "water hammers", a 3 sec. delay is given between pump off and solenoid valve off (Ev1) and a 2 sec. delay is given between pump off and pressure pump off.

If a "SYSTEM STOPPED!" message occurs, unplug the instrument, verify and correct the fault and plug the instrument to reset the alarm. Otherwise, enter into "SETUP" menu, verify and correct the fault and exit from menu.

### - HI PRESSURE ALARM

During water production, if high pressure alarm occurs, the system stops, alarm output is active and display shows:

SYSTEM STOPPED!  
hi pressure

### - LOW PRESSURE ALARM

During water production, if high pressure alarm occurs, the system stops, alarm output is active and display shows:

SYSTEM STOPPED!  
low pressure

### - PUMP TEMP.

During water production, if temperature switch (pressure pump) is active, the system stops, alarm output is active and display shows:

SYSTEM STOPPED!!  
pump temp.

### - CONDUCTIVITY ALARM

During water production, if conductivity exceeds the setpoint for a set time, or if, at the end of washing, is exceeding the setpoint (see page 16-17), the system stops, alarm output is active and display shows:

SYSTEM STOPPED!  
conductivity

### - HI AND LOW LEVEL CONTACT

If a failure occurs in opening /closing contact sequence (when filling/emptying a tank), check high and low level contacts. The system stops, alarm output is active and display shows:

monitoring  
cont hi AND lo lev

---

## PROGRAMMING

---

### MAIN MENU ACCESS

Press "ENTER" for about 2 sec. to enter into programming menu (Main menu).

Enter the password using "UP", "DOWN", "LEFT" and "RIGHT" then press "ENTER" to confirm. Default password is "0000".

P A S S W O R D  
0 0 0 0

Change password from MAIN MENU (submenu 17 - Password).

Note:

For lost password please refer to "RESET PASSWORD" procedure, as described on page 7.

# MAIN MENU

## MAIN MENU

Press ENTER to enter into submenu.  
Keep pressed "ESC" for 2 sec. to exit.

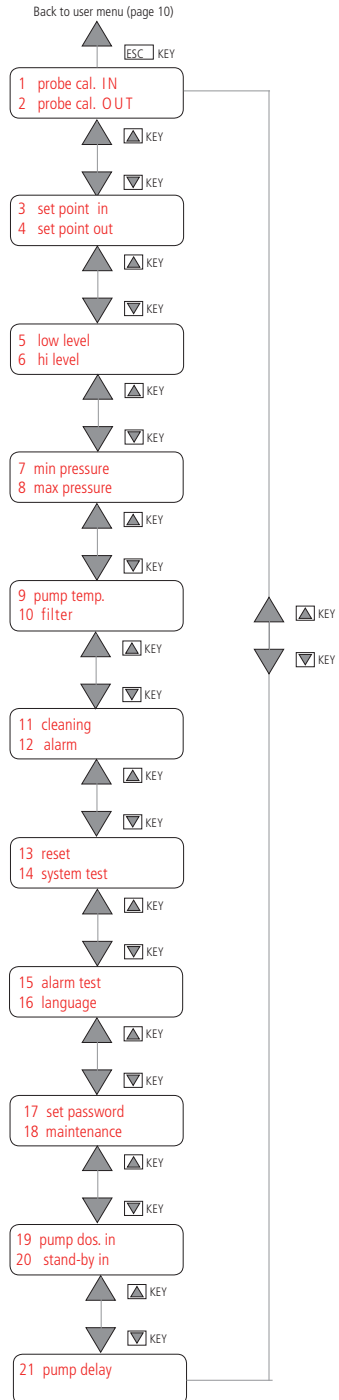

# MAIN MENU

## 1 - INPUT PROBE CALIBRATION

Select "1A ZERO CALIB" for zero calibration. Connect the probe and keep it in the air.

Confirm, by ENTER key, the value read in "READING" field. If wrong data, agreed over 50  $\mu\text{s}$ , instrument will display "ZERO error cal". Repeat calibration or press ESC to exit without save.

Back to main menu (p. 14)

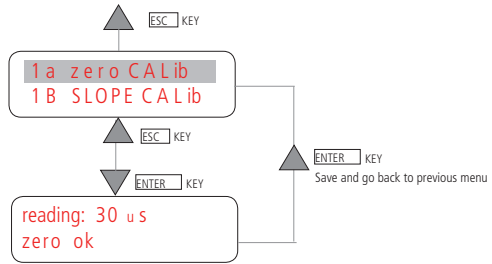

Select "1B SLOPE CALIB" for Slope calibration. Set buffer solution value (0 to 999  $\mu\text{s}$ ).

Insert probe into buffer solution. Wait until a stable value and press ENTER to save and exit, or ESC to exit without save.

Attention: BUFFER field value must not be 0, otherwise the value will not be saved.

Back to main menu (p. 14)

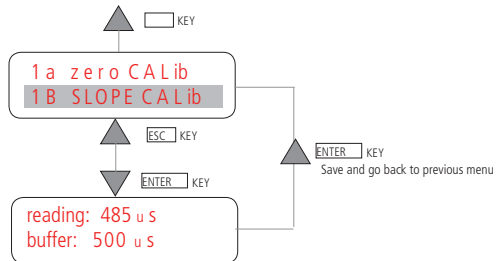

## 2 - OUTPUT PROBE CALIBRATION

Select "2A ZERO CALIB" for zero calibration. Connect the probe and keep it in the air. Confirm, by ENTER key, the value read in "READING" field. If wrong data, agreed over 50  $\mu\text{S}$ , instrument will display "ZERO error cal". Repeat calibration or press ESC to exit without save.

Back to main menu (p. 14)

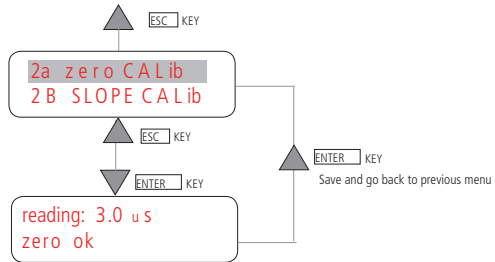

Select "2B SLOPE CALIB" for Slope calibration. Set buffer solution value (0 to 99.9  $\mu\text{S}$ ). Insert probe into buffer solution. Wait until a stable value and press ENTER to save and exit, or ESC to exit without save. Attention: BUFFER field value must not be 0, otherwise the value will not be saved.

Back to main menu (p. 14)

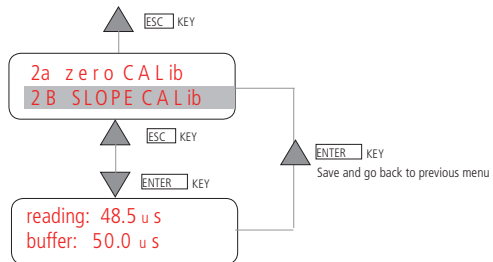



---

---

### 3 – SETPOINT OUT

Setpoint out control the conductivity value of the water out.

During water production, if conductivity value is over the value set (in 3B) for a time set in "3D INPUT DELAY" field, the alarm output will be active, the instrument stops and the display shows a conductivity alarm message ("SYSTEM STOPPED! CONDUCT. ALARM").

"3B SETPOINT": set between 0.0 and 99.9  $\mu\text{S}$  (or 999 $\mu\text{S}$ , depending on version).

Set a value different from 0.

"3C END WASH": it can be stopped or disabled.

At wash ending:

- if "3C END WASH ENABLED" and conductivity value is over the setpoint:

- alarm output actived,
- instrument blocked,
- alarm message displayed ("SYSTEM STOPPED! CONDUCT. ALARM").

- If "3C END WASH DISABLED" instrument continues working.

If alarm occurs:

- power off, restore normal condition and power on instrument.

Otherwise:

- enter into "SETUP" menu, restore normal condition and exit from "SETUP" menu.



SYSTEM STOPPED!  
CONDUCT. ALARM

"3D INPUT DELAY": from 0M and 00Sec to 9M and 59Sec.



---

---

## 4 – SETPOINT IN

Setpoint in control the conductivity value of the water in.

During water production, if conductivity value is over the value set (in 4B) for a time set in "4C INPUT DELAY" field, the alarm output will be active.

IF: "4D INSTR. ON HOLD YES" and conductivity is over the setpoint:

- alarm output actived,
- Instrument blocked,
- alarm message displayed ("SYSTEM STOPPED! CONDOC. ALARM").

IF: "4D INSTR. ON HOLD NO" and conductivity is over the setpoint the instrument continue working:

- alarm output actived,
- Instrument does not blocked,
- alarm message displayed ("SYSTEM STOPPED! CONDOC. ALARM").

If alarm occurs:

- power off, restore normal condition and power on instrument.

Otherwise:

- enter into "SETUP" menu, restore normal condition and exit from "SETUP" menu.

"4B SETPOINT": set between 0.0 and 99.9  $\mu$ S (or 999 $\mu$ S, depending on version).

Set a value different from 0.

"4C INPUT DELAY": set between 0M and 00Sec to 9M and 59Sec.

"4D INSTR. ON HOLD": YES or NO

Back to main menu (p. 14) without saving

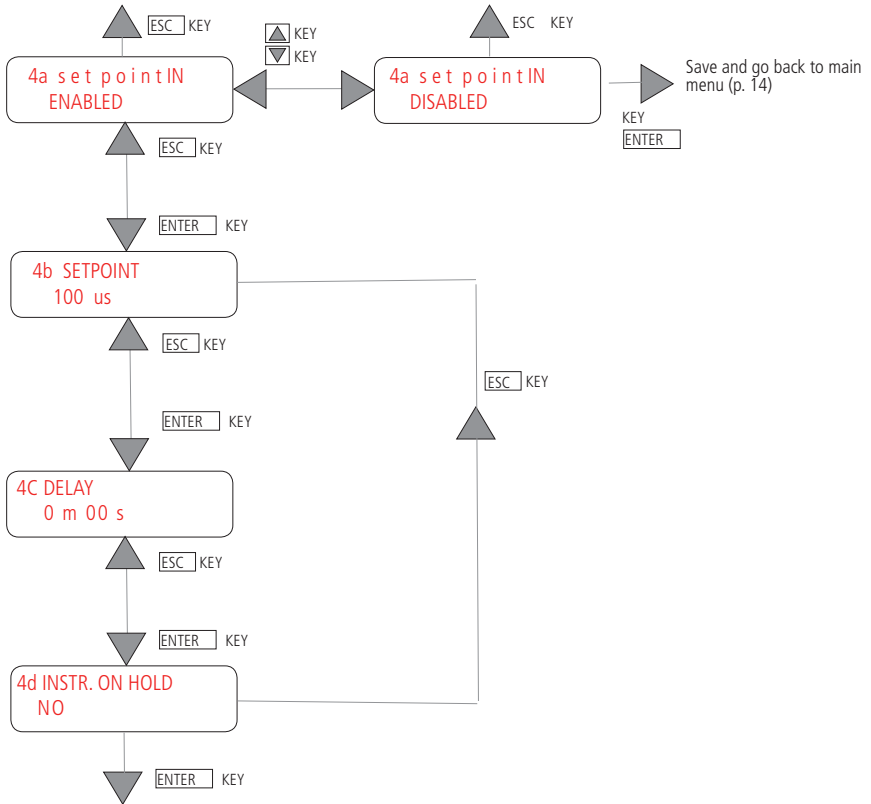

Save and go back to main menu (p. 14)

## 5 - LOW LEVEL

LOW LEVEL input can be ENABLED or DISABLED.

“5B CONTACT”: N.O.: normally open or N.C.: normally closed. The value set means the input acquisition mode.

“5C INPUT DELAY”: the delay in status change acquisition. It allows to wait the float stabilization.  
Delay range between 0 and 59 Sec.

If a failure occurs in opening /closing contact sequence (when filling/emptying a tank), check high and low level contacts. The system stops, alarm output is active and display shows:

monitoring  
cont hi AND lo lev

Unplug the instrument, verify and correct the fault and plug the instrument to reset the alarm.  
Otherwise, enter into “SETUP” menu, verify and correct the fault and exit from menu.

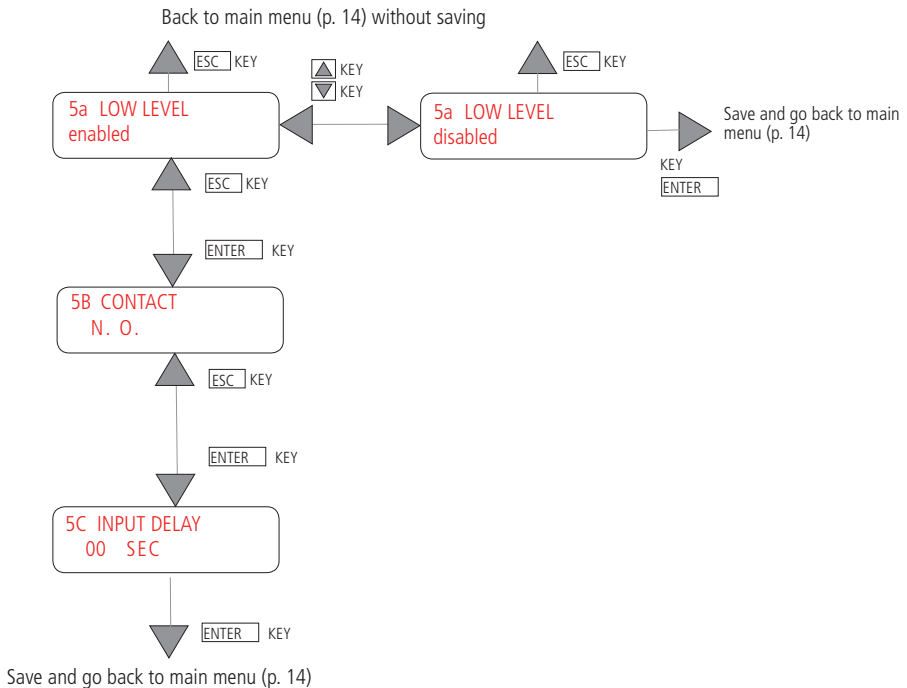

## 6 - HI LEVEL

HIGH LEVEL input can be ENABLED or DISABLED.

“6B CONTACT”: N.O.: normally open or N.C.: normally closed. The value set means the input acquisition mode.

“6C INPUT DELAY”: the delay in status change acquisition. It allows to wait the float stabilization.  
Delay range between 0 and 59 Sec.

If a failure occurs in opening /closing contact sequence (when filling/emptying a tank), check high and low level contacts. The system stops, alarm output is active and display shows:

monitoring  
cont hi AND lo lev

Unplug the instrument, verify and correct the fault and plug the instrument to reset the alarm.  
Otherwise, enter into “SETUP” menu, verify and correct the fault and exit from menu.

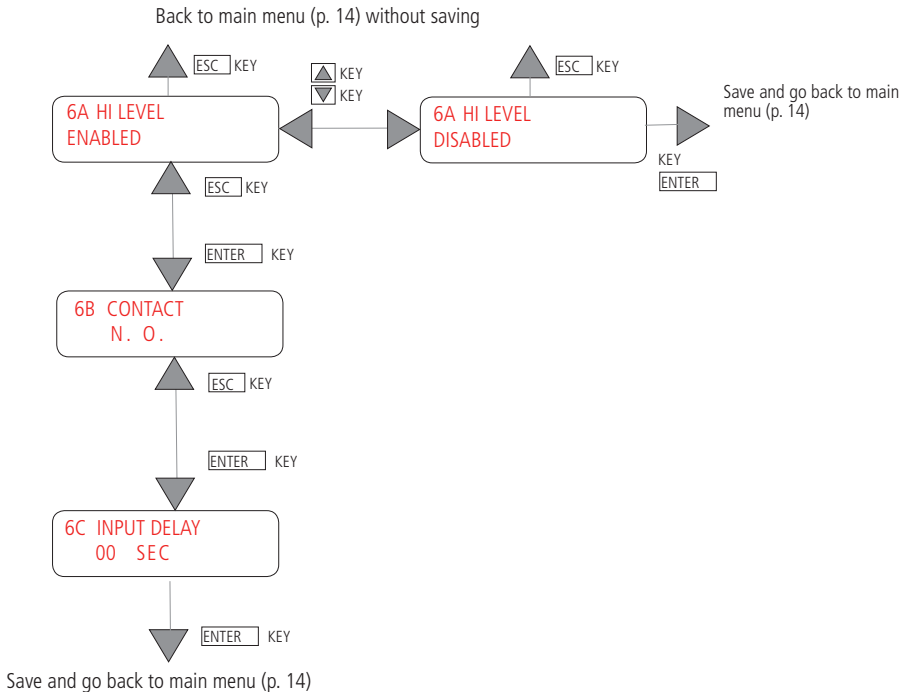

---

---

## 7 - LOW PRESSURE

LOW PRESSURE contact input can be ENABLED or DISABLED. If enabled, if the pressure decreases under setpoint, instrument will stop after more LOW PRESSURE alarms occurs in 10 minutes.

"7B CONTACT": N.O.: normally open or N.C.: normally closed. The value set means the input acquisition mode.

"7C INPUT DELAY": the delay in status change acquisition. It allows to wait the contact pressure stabilization. Delay range between 0 and 59 Sec.

"7D MAX RETRY": maximum number of alarm messages that may occur within 10 minutes from the first alarm (0 to 9). Set to 0, the occurrence of the first alarm of low pressure, instrument stops (all outputs are disabled) displaying the message (ref. p. 12):

SYSTEM STOPPED!  
low pressure

Setting a value different from 0, if a low pressure alarm occurs, display will show the number of alarm messages on the total set. Dosing pump and pressure pump stop; EV1 on.  
If pressure go back to standard value, alarm will be delated.

RETRY 1/4  
LOW PRESSURE

If pressure remain low after 5 minutes, instrument try to restore the pressure for a number of attempts set.  
After all attempts, all outputs are disabled (osmosis is stopped) displaying the message (ref. p. 12):

SYSTEM STOPPED!  
low pressure

After 20 minutes of standard working mode, the number of attempts is reset.

"7E ALL. WASHING": enable low pressure alarm during washing. Default value: YES.

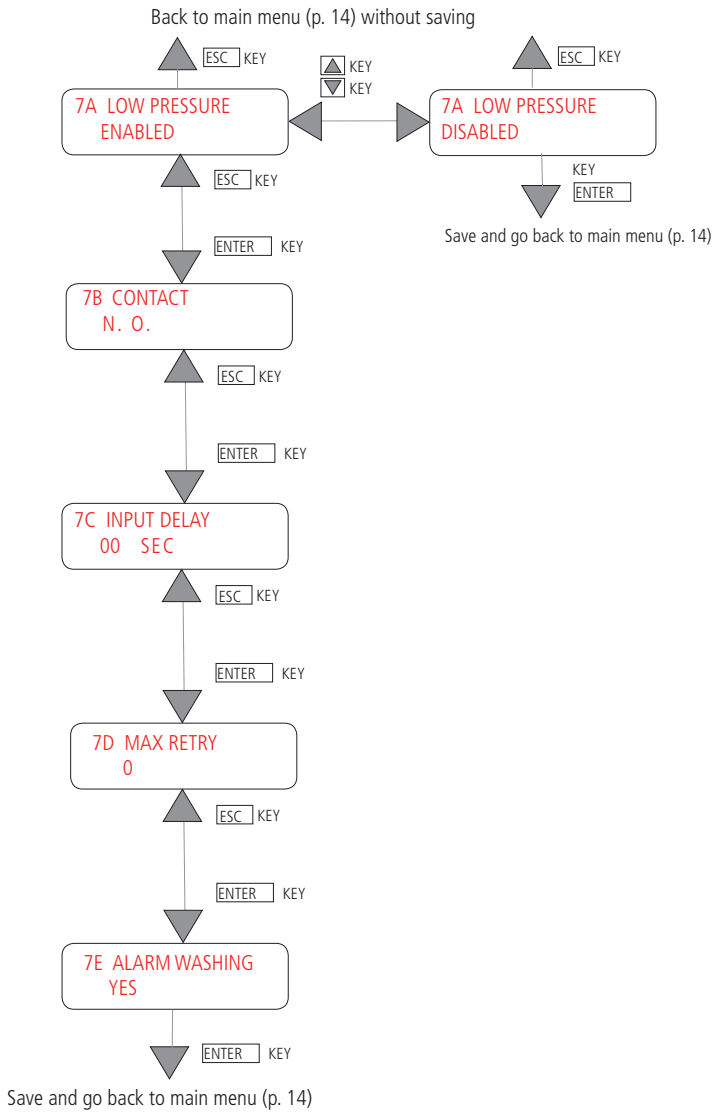



## 8 - MAX PRESSURE

MAX PRESSURE contact input can be ENABLED or DISABLED. If enabled, if the pressure increases instrument will stop displaying (ref. p. 12):

SYSTEM STOPPED!  
hi pressure

"8B CONTACT": N.O.: normally open or N.C.: normally closed. The value set means the input acquisition mode.

"8C INPUT DELAY": the delay in status change acquisition. It allows to wait the contact pressure stabilization. Delay range between 0 and 59 Sec.

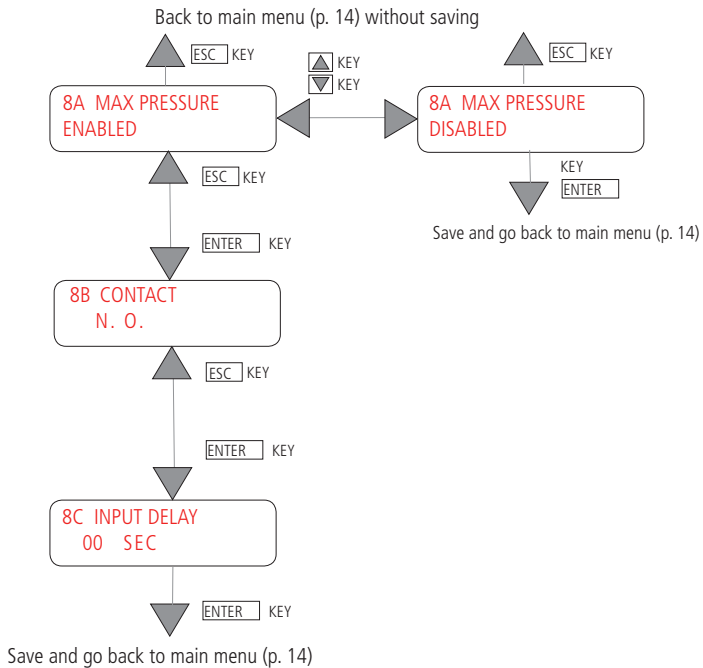

---

## 9 - PUMP TEMP IN

PUMP TEMP IN contact input can be ENABLED or DISABLED.

Pressure pump motor is thermostat protected. If pressure pump temperature increases, the thermostat closes and stops the instrument. The display shows (ref. p. 12):

**SYSTEM STOPPED!  
PUMP TEMP.**

“9B CONTACT”: N.O.: normally open or N.C.: normally closed.

The value set means the input acquisition mode.

“9C INPUT DELAY”: the delay in status change acquisition. It allows to wait the thermostat contact stabilization. Delay range between 0 and 59 Sec.

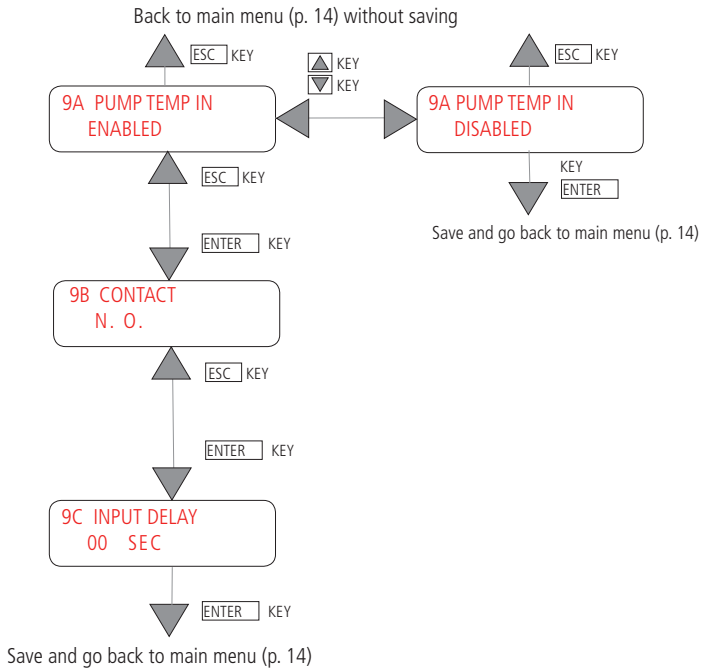

---

---

## 10 - FILTER

FILTER contact input can be ENABLED or DISABLED.

Enable contact if a water softener is connected before the instrument.

When the softner ends regeneration, instrument stops and display shows (ref. p. 12):

System waiting!  
filter input

"10B CONTACT": N.O.: normally open or N.C.: normally closed.

The value set means the input acquisition mode.

"10C INPUT DELAY": the delay in status change acquisition. It allows to wait the filter contact input stabilization. Delay range between 0 and 59 Sec.

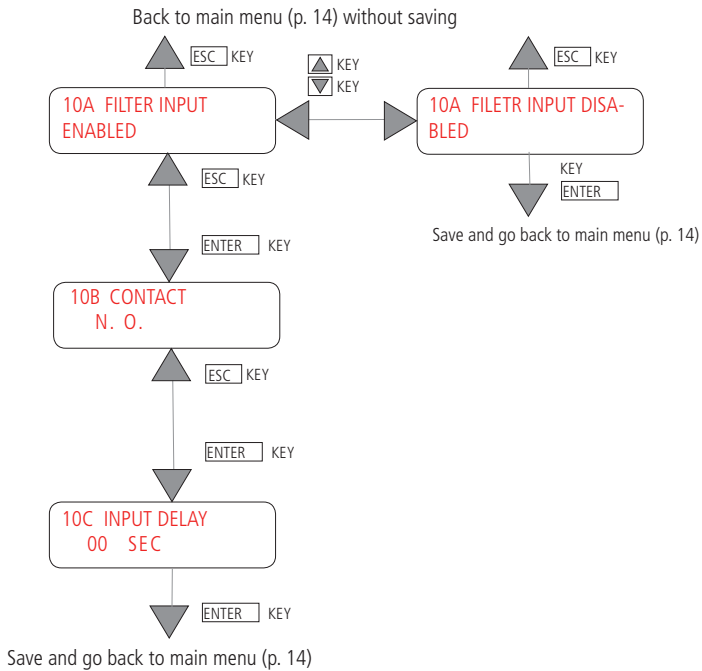

---

---

## 11 - WASHING (membrane washing cycle)

WASHING contact input can be ENABLED or DISABLED.

If enabled, during Membrane Washing menu on p. 9 is displayed.

"11B PUMP": YES to enable a washing cycle with pump; NO to enable a washing cycle without pump (sequence on p. 7-8).

"11C EVIN": YES to enable a washing cycle with solenoid valve 1 (EVIN); NO to enable a washing cycle without solenoid valve.

"11D START PROD.": if enabled, a membrane washing of a set time (11E TIME), max 99min and 59 sec, is performed before any water production.

"11F END PROD.": if enabled, a membrane washing of a set time (11G TIME), max 99min and 59 sec, is performed after any water production.

"11H WASH CYCLE": it is possible to set a cyclic membrane washing every n hours (from "00hr" to "99hr") and for a set length (from "00min 00sec" to "99min 59sec")

Set "00hr", means to disable cyclic washing.

Cycle washing does when controller is in "waiting mode" (osmosis stopped) except if:

- instrument is in OFF status. The washing cycle will be performed when ON;

- user is in Programming Mode. The washing cycle will be performed at Programming Mode ending (exit from Main Menu).

Set wash cycle rae performed also during STAND-BY.

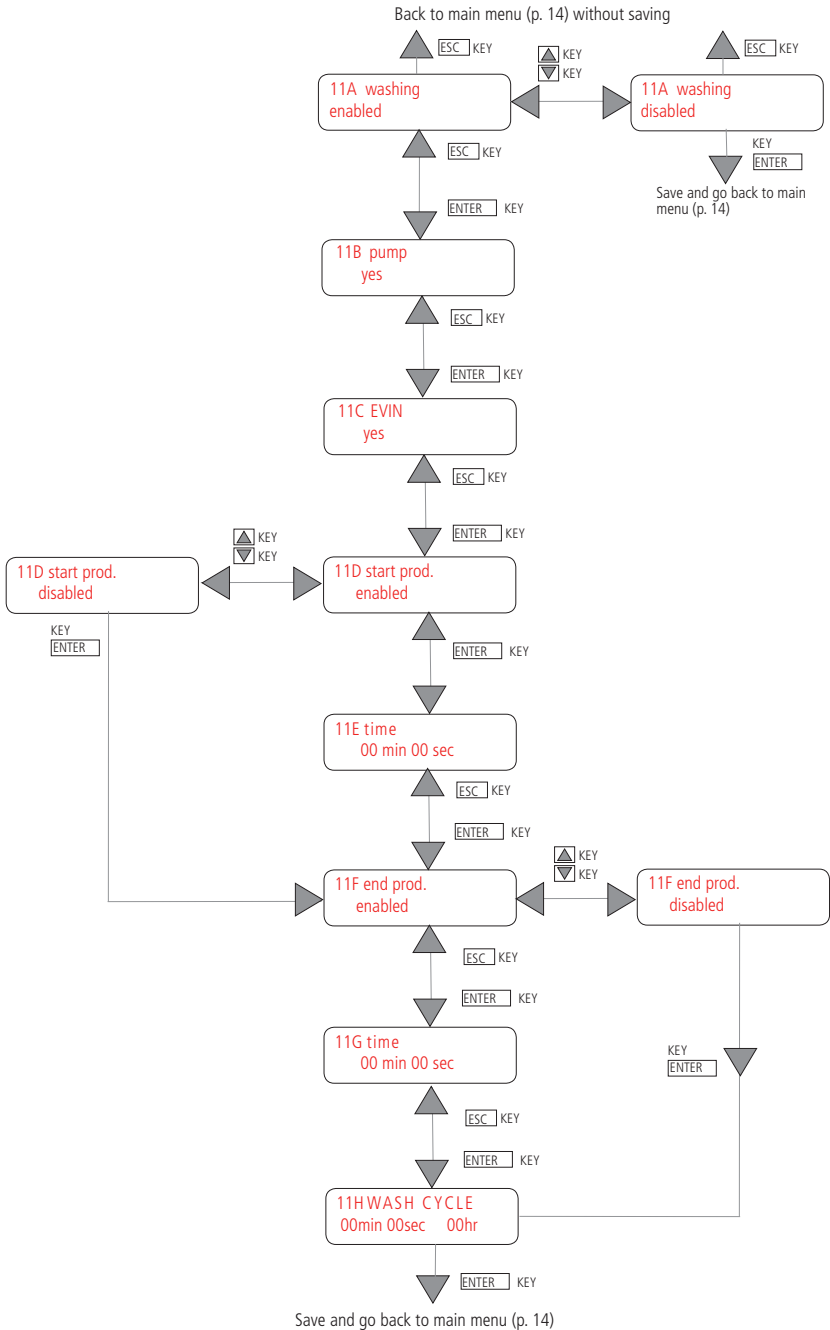

---

---

## 12 - OUTPUT ALARM

OUTPUT ALARM contact input can be ENABLED or DISABLED.

"12B CONTACT": N.O.: normally open or N.C.: normally closed. The value set means the input acquisition mode.

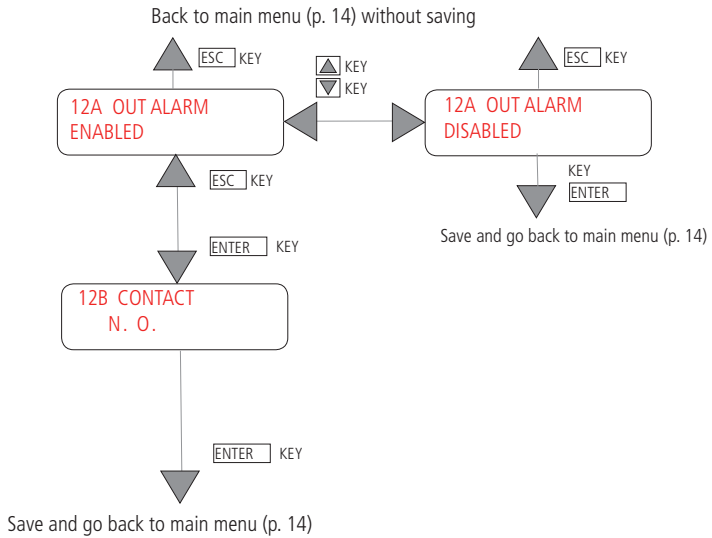

---

## 13 - RESET Hr Counter

RESET Hr COUNTER is a water production timer.

Working time is shown in User Menu (p. 10).

Each water production hour decreases the counter in "SERVICE BETWEEN" field (User menu on p. 10) until 0. Then a "PERFORM MAINTENANCE" message will appear if enabled in submenu 18 (p. 30). Reset the message setting YES in 13B screen. Resolution is 0.1 and saving is once per hour.

"13A RES HR COUNT.: YES to reset water production timer.

"13A RES SERVICE": YES to restore "SERVICE BETWEEN" field the value set in submenu 17 (100 hr default value).

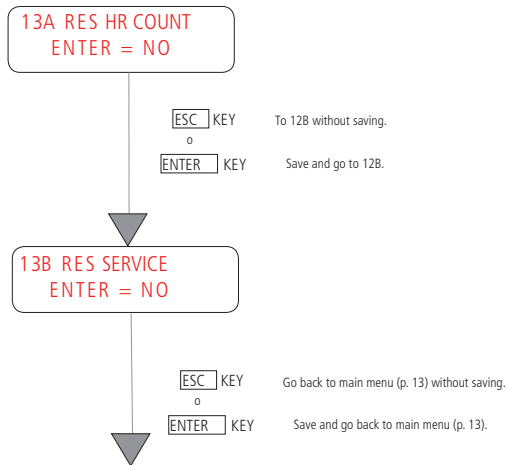

---

---

## 14 - SYSTEM TEST

SYSTEM TEST to test plant function.

Each screen is shown for 3 sec. and it suggests the keys to check the functions.

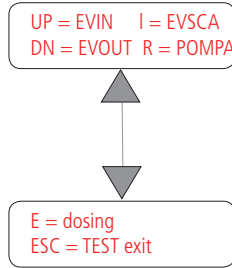

- Press:
- UP to enable EVIN (Solenoid valve EV1)
  - L (LEFT) to enable EVSCA (Elettrovalvola di scarico EV3)
  - DN (DOWN) to enable EVOUT (Elettrovalvola d'uscita EV2)
  - R (RIGHT) to enable pressure pump
  - E (ENTER) to enable pressure pump

Press again to disable the functions. Press ESC to go back to main menu.

## 15 - ALARM TEST

ALARM TEST to test alarm output.



- Press:
- UP to enable alarm
  - ESC to test exit.

Press again UP to disable the function.

## 16 – LANGUAGE

Select language from this menu: italian or english or french or deutsch or spanish.

Use Up and DOWN keys to scroll menu and ENTER to confirm.



---

---

## 17 - PASSWORD

Enter into PASSWORD menu to change password. Default password is 0000.

Edit old password (or 0000 for first entry) using UP/DOWN keys to increase/decrease digits and LEFT/RIGHT to move on digits.

Edit new password and confirm.

A wrong entry will be pointed out by a WRONG PASSWORD message.

## 18 – (PERFORM MAINTENANCE) MESSAGE

“PERFORM MAINTENANCE” message can be ENABLED or DISABLED.

After 100 hours (default value) of water production, the message will appear. The counter can be changed up to 19999 hours. Set on 0 to disable alarm message.

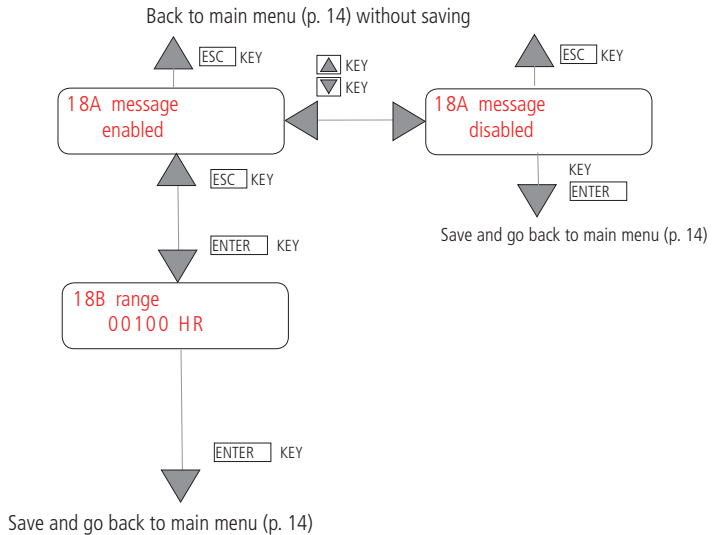

---

## 19 – PUMP DOS. IN

PUMP DOS. IN (pump dosing alarm input) contact can be enabled or disabled.

“19B CONTACT”: N.O.: normally open or N.C.: normally closed.  
The value set means the input acquisition mode.

“19C INPUT DELAY”: the delay in status change acquisition.  
Delay range between 0 and 59 Sec.

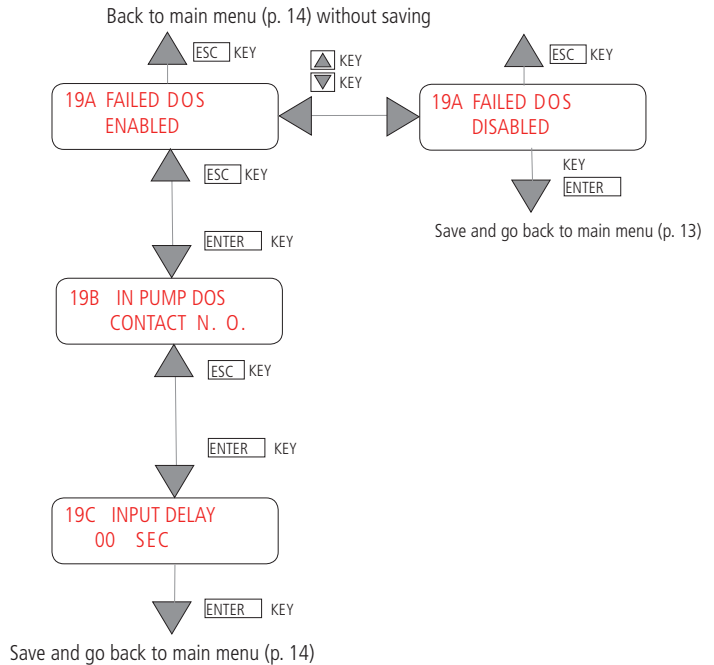

If a pump alarm occurs, if PUMP DOS. IN contact is enabled, instrument shows “SYSTEM WAITING - FAILED DOSAGE” and alarm output is active.

The alarm resets at pump alarm end.

---

---

## 20 – IN STAND BY

STAND BY input contact can be ENABLED or DISABLED.

“20B CONTACT”: N.O.: normally open or N.C.: normally closed.  
The value set means the input acquisition mode.

“20C INPUT DELAY”: the delay in status change acquisition.  
Delay range between 0 and 59 Sec.

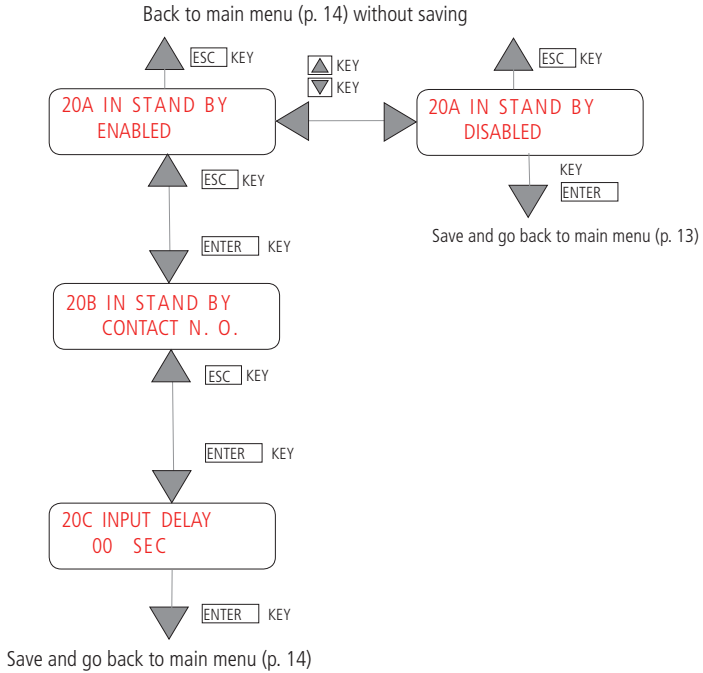

---

---

## 21 – PUMP DELAY

Set a pump delay: the pump will start before electrovalve. Max: 300 sec.

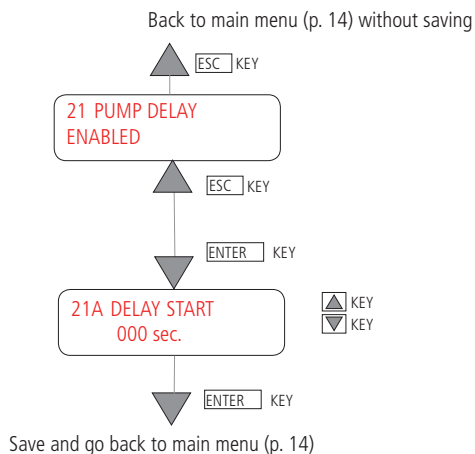

If a delay is set, after electrovalve start the instrument shows:

WAITING FOR THE  
ACTIVATION PUMP

# SCHEMA DI PRINCIPIO LD-OSIN

Numbers between parenthesis refer to terminal board.

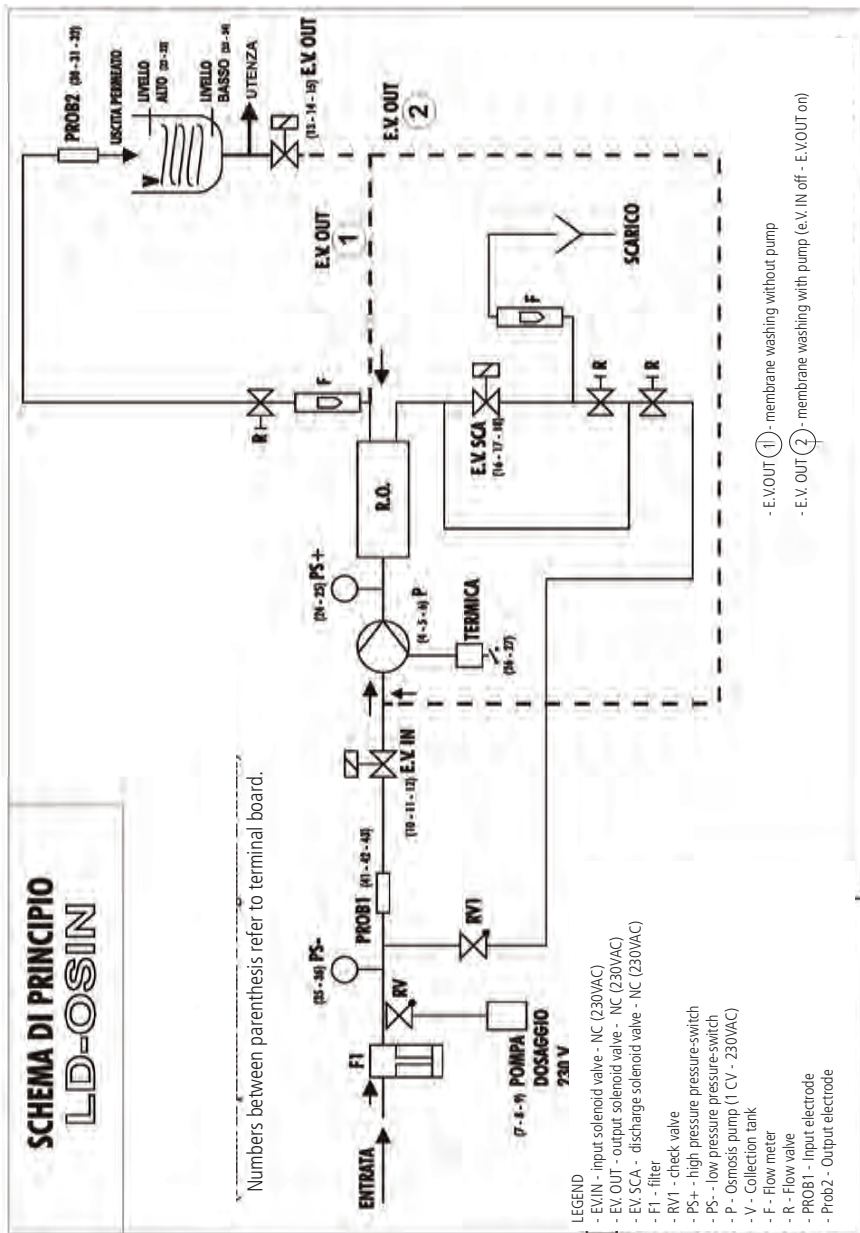

## LEGEND

- EV.IN - input solenoid valve - NC (230VAC)
- EV.OUT - output solenoid valve - NC (230VAC)
- EV.SCA - discharge solenoid valve - NC (230VAC)
- F1 - filter
- RV1 - check valve
- PS+ - high pressure pressure-switch
- PS- - low pressure pressure-switch
- P - Osmosis pump (1 CV - 230VAC)
- V - Collection tank
- F - Flow meter
- R - Flow meter
- PROB1 - Input electrode
- PROB2 - Output electrode

- E.V.OUT (1) - membrane washing without pump

- E.V.OUT (2) - membrane washing with pump (e.v.in off - E.V.OUT on)

# DIMENSION

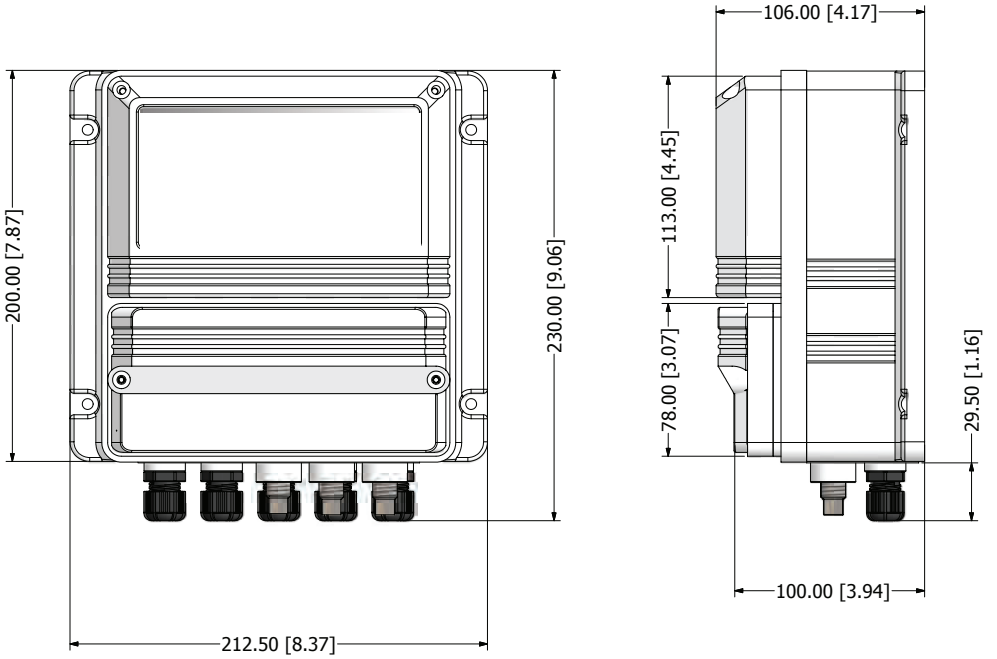

mm [inches]

## RACK MOUNTING DIMENSION

DEPTH 80,00 mm

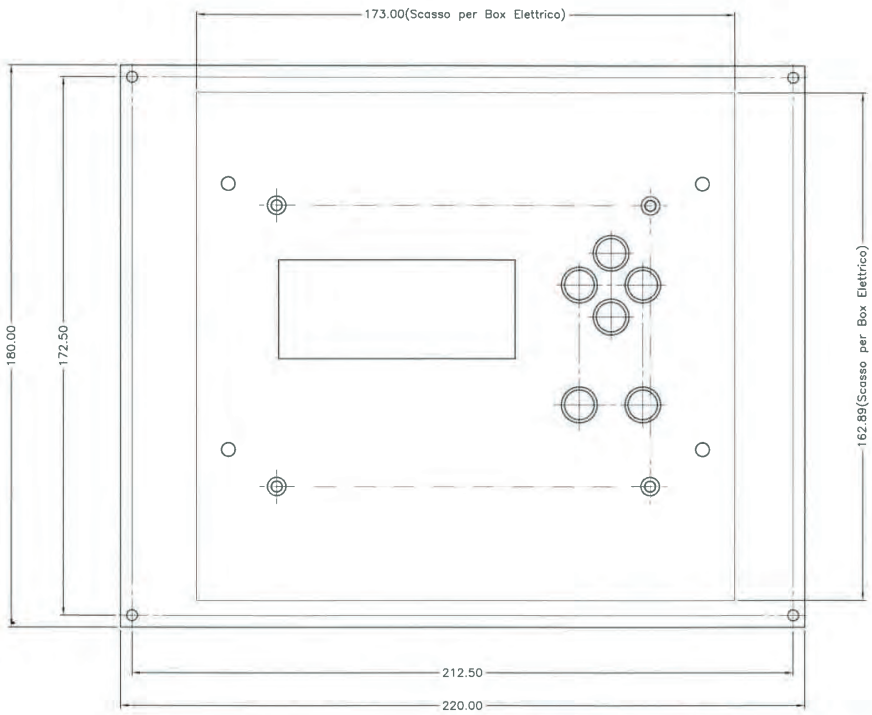



### **Disposal of end-of-life equipment by users**

This symbol warns you not to dispose of the product with normal waste. Respect human health and the environment by giving the discarded equipment to a designated collection center for the recycling of electronic and electrical equipment. For more information visit the online site.



When dismantling a pump please separate material types and send them according to local recycling disposal requirements. We appreciate your efforts in supporting your local Recycle Environmental Program. Working together we'll form an active union to assure the world's invaluable resources are conserved.